

OPTIREG™ Linear TLE4299V33

Low drop fixed voltage regulator



Features

- Output voltage $3.3\text{ V} \pm 2\%$
- 150 mA Output current
- Extreme low current consumption in ON state
- Inhibit function: Below $1\ \mu\text{A}$ current consumption in off mode
- Early warning
- Reset output low down to $V_Q = 1\text{ V}$
- Overtemperature protection
- Reverse polarity proof
- Wide temperature range
- Green Product (RoHS compliant)

Potential applications

General automotive applications.

Product validation

Qualified for automotive applications. Product validation according to AEC-Q100/101.

Description

The OPTIREG™ Linear TLE4299V33 is a monolithic voltage regulator with fixed 3.3 V output, supplying loads up to 150 mA. It is especially designed for applications that may not be powered down while the motor is off. In addition the TLE4299GMV33 includes an inhibit function. When the inhibit signal is removed, the device is switched off and the quiescent current is less than $1\ \mu\text{A}$. To achieve proper operation of the μ -controller, the device supplies a reset signal. The reset delay time is selected application-specific by an external delay capacitor. The reset threshold is adjustable. An early warning signal supervises the voltage at pin SI. The TLE4299V33 is pin-compatible to the TLE4269 and functional similar with the additional inhibit function. The TLE4299V33 is designed to supply microcontroller systems even under automotive environment conditions. Therefore it is protected against overload, short circuit and overtemperature.

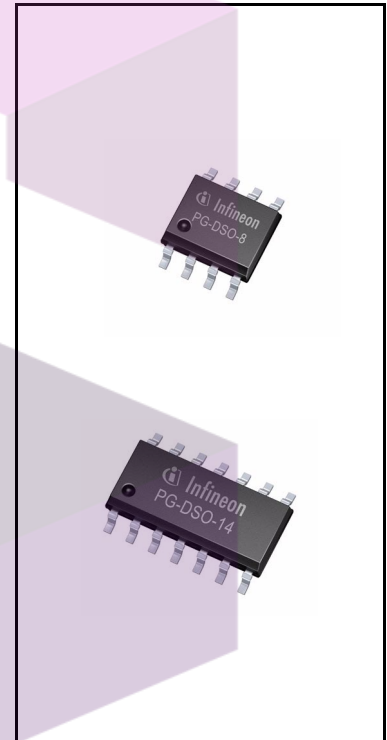

Type	Package	Marking
TLE4299GV33	PG-DSO-8	4299V33
TLE4299GMV33	PG-DSO-14	4299V33

Table of contents

	Features	1
	Potential applications	1
	Product validation	1
	Description	1
	Table of contents	2
1	Block diagram	3
2	Pin configuration	4
3	General product characteristics	6
3.1	Absolute maximum ratings	6
4	Functional description	8
4.1	Electrical characteristics	9
4.2	Test circuit	11
4.3	Typical performance characteristics	12
5	Application information	17
5.1	Reset	19
5.2	Early warning	21
6	Package information	22
7	Revision history	24

SKYTECH

تهیه و توزیع قطعات الکترونیک

Block diagram

1 Block diagram

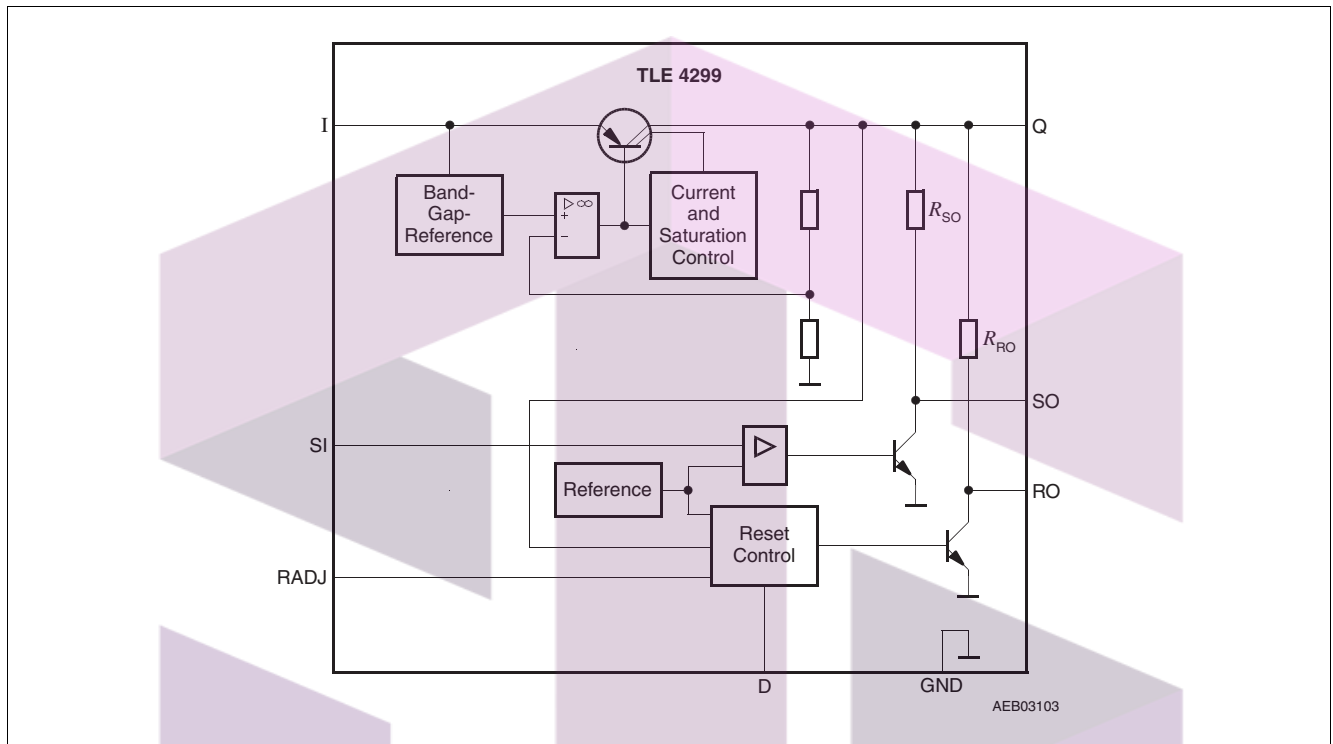

Figure 1 Block diagram TLE4299GV33

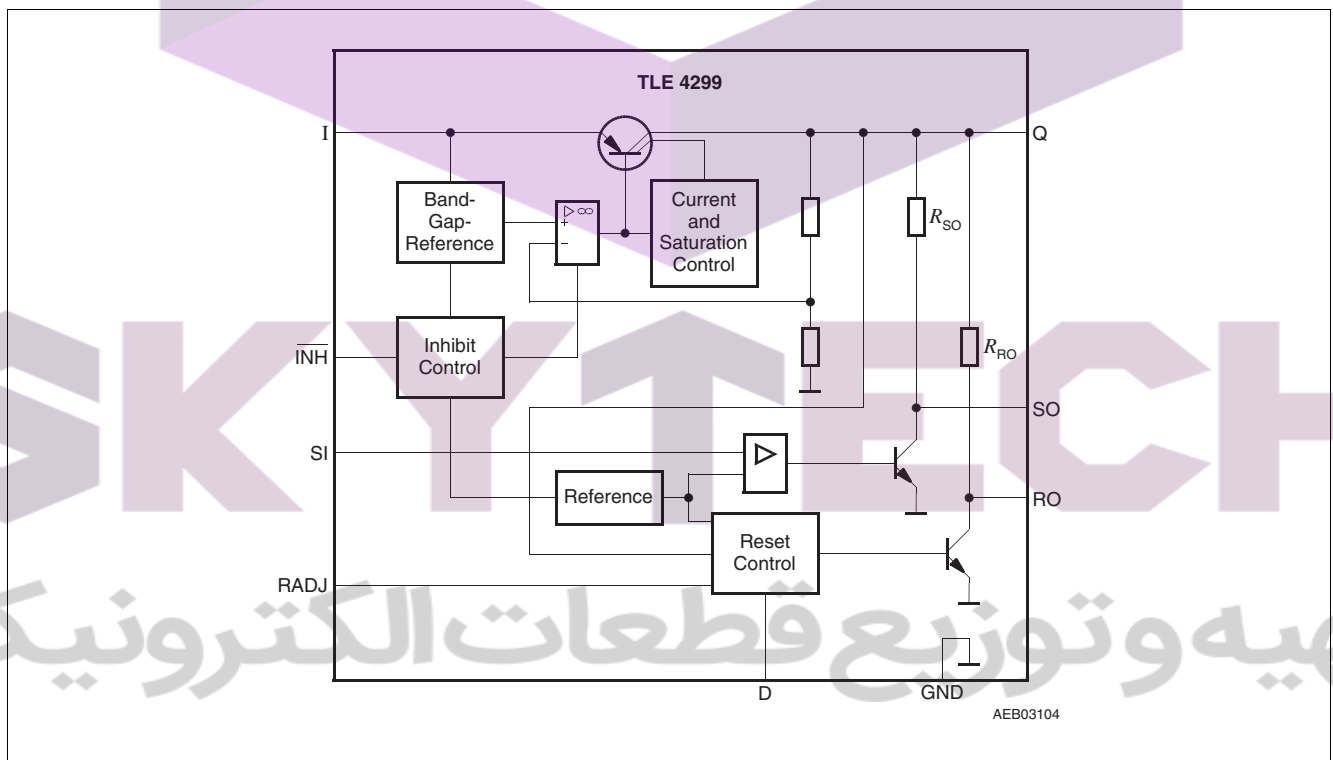

Figure 2 Block diagram TLE4299GMV33

Pin configuration

2 Pin configuration

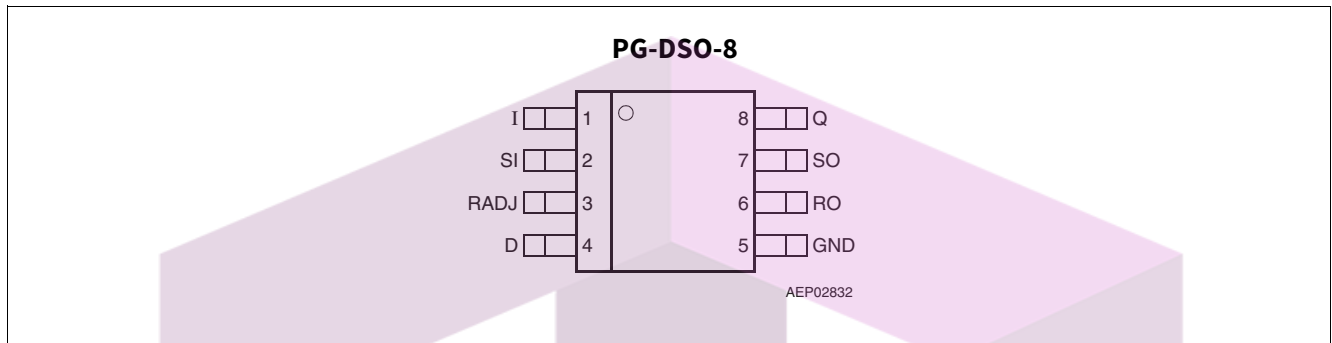

Figure 3 Pin configuration PG-DSO-8 (top view)

Table 1 Pin definitions and functions (TLE4299GV33)

Pin No.	Symbol	Function
1	I	Input; block directly to GND on the IC with a ceramic capacitor.
2	SI	Sense input; if not needed connect to Q.
3	RADJ	Reset threshold adjust; if not needed connect to GND.
4	D	Reset delay; to select delay time, connect to GND via external capacitor.
5	GND	Ground
6	RO	Reset output; the open-collector output is linked internally to Q via a 20 kΩ pull-up resistor. Keep open, if the pin is not needed.
7	SO	Sense output; open-collector output. Keep open, if the pin is not needed.
8	Q	Output; connect to GND with a 22 μF capacitor, $0.4 \Omega < \text{ESR} < 3.7 \Omega$. ¹⁾

1) See characteristic curves.



Pin configuration

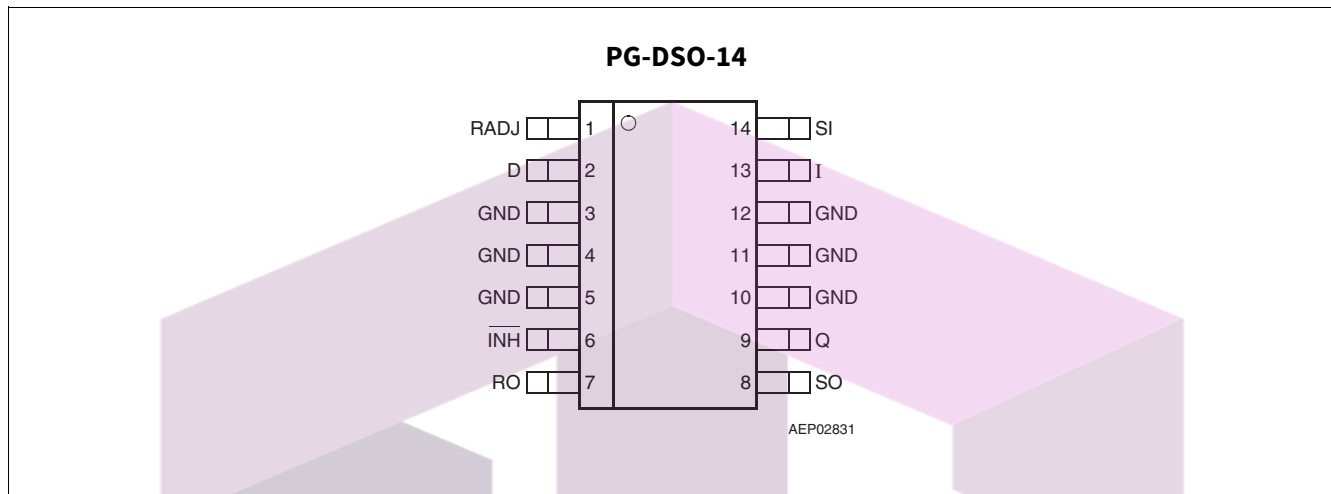

Figure 4 Pin configuration PG-DSO-14 (top view)

Table 2 Pin definitions and functions (TLE4299GMV33)

Pin No.	Symbol	Function
1	RADJ	Reset threshold adjust; if not needed connect to GND.
2	D	Reset delay; connect to GND via external delay capacitor for setting delay time.
3, 4, 5	GND	Ground
6	$\overline{\text{INH}}$	Inhibit; if not needed connect to Input pin I; A high signal switches the regulator ON.
7	RO	Reset output; the open-collector output is linked internally to Q via a 20 k Ω pull-up resistor. Keep open, if the pin is not needed.
8	SO	Sense Output; open-collector output. Keep open, if the pin is not needed.
9	Q	Output; connect to GND with a 22 μF capacitor, $0.4 \Omega < \text{ESR} < 3.7 \Omega$. ¹⁾
10, 11, 12	GND	Ground
13	I	Input; block to GND directly at the IC by a ceramic capacitor.
14	SI	Sense input; if not needed connect to Q.

1) See characteristic curves.



General product characteristics

3 General product characteristics

3.1 Absolute maximum ratings

Table 3 Absolute maximum ratings

-40°C ≤ T_j ≤ 150°C; all voltages with respect to ground, positive current flowing into pin (unless otherwise specified)

Parameter	Symbol	Values			Unit	Note or Test Condition
		Min.	Typ.	Max.		
Input I						
Input voltage	V _I	-40	-	45	V	-
Inhibit input $\overline{\text{INH}}$						
Input voltage	V _{INH}	-40	-	45	V	-
Sense input SI						
Input voltage	V _{SI}	-0.3	-	45	V	-
Input current	I _{SI}	-1	-	1	mA	-
Reset threshold adjust RADJ						
Input voltage	V _{RADJ}	-0.3	-	7	V	-
Input current	I _{RADJ}	-10	-	10	mA	-
Reset delay D						
Voltage	V _D	-0.3	-	7	V	-
Reset output RO						
Voltage	V _R	-0.3	-	7	V	-
Sense output SO						
Voltage	V _{SO}	-0.3	-	7	V	-
Output Q						
Output voltage	V _Q	-0.3	-	7	V	-
Output current	I _Q	-5	-	-	mA	-
Temperature						
Junction temperature	T _j	-	-	150	°C	-
Storage temperature	T _{Stg}	-50	-	150	°C	-
Operating range						
Input voltage	V _I	4.4	-	45	V	-
Junction temperature	T _j	-40	-	150	°C	-

General product characteristics

Table 3 Absolute maximum ratings (cont'd)

-40°C ≤ T_j ≤ 150°C; all voltages with respect to ground, positive current flowing into pin (unless otherwise specified)

Parameter	Symbol	Values			Unit	Note or Test Condition
		Min.	Typ.	Max.		
Thermal data						
Junction-ambient for foot print only ¹⁾	R _{thja}	-	-	200	K/W	PG-DSO-8
				130	K/W	PG-DSO-14
Junction-ambient for 300 mm ² cooling area ²⁾	R _{thja}	-	-	164	K/W	PG-DSO-8
				70	K/W	PG-DSO-14
Junction-pin	R _{thjp}	-	-	60	K/W	PG-DSO-8 ³⁾
				30	K/W	PG-DSO-14 ⁴⁾

1) FR4, 80 × 80 × 1,5 mm; 35 μm Cu, 5 μm Sn; Footprint only.

2) FR4, 80 × 80 × 1,5 mm; 35 μm Cu, 5 μm Sn; 300 mm².

3) Measured to pin 5.

4) Measured to pin 4.

Note: Stresses above those listed here may cause permanent damage to the device. Exposure to absolute maximum rating conditions for extended periods may affect device reliability. In the operating range, the functions given in the circuit description are fulfilled.

SKYTECH

تهیه و توزیع قطعات الکترونیک

Functional description

4 Functional description

The TLE4299V33 is a PNP based very low drop linear voltage regulator. It regulates the output voltage to $V_Q = 3.3\text{ V}$ for an input voltage range of $4.4\text{ V} \leq V_I \leq 45\text{ V}$. The control circuit protects the device against potential damages caused by overcurrent and overtemperature. The internal control circuit achieves a 3.3 V output voltage with a tolerance of $\pm 2\%$.

The device includes a power on reset and an undervoltage reset function with adjustable reset delay time and adjustable reset switching threshold as well as a sense control/early warning function. The device includes an inhibit function to disable it when the ECU is not used for example while the motor is off.

The reset logic compares the output voltage V_Q to an internal threshold. If the output voltage drops below this level, the external reset delay capacitor C_D is discharged. When V_D is lower than V_{ST} , the reset output RO is switched “low”. If the output voltage drop is very short, the V_{ST} level is not reached and no reset-signal is asserted. This feature avoids resets at short negative spikes at the output voltage e.g. caused by load changes. As soon as the output voltage is more positive than the reset threshold, the delay capacitor is charged with constant current. When the voltage reaches V_{DT} the reset output RO is set “high” again.

The reset delay time and the reset reaction time are defined by the external capacitor C_D . The reset function is active down to $V_I = 1\text{ V}$.

In addition to the normal reset function, the device gives an early warning. When the SI voltage drops below $V_{SI,low}$, the device asserts the SI output “low” to indicate the logic and the μ -processor that this voltage has dropped. The sense function uses a hysteresis: When the SI-voltage reaches the $V_{SI,high}$ level, SO is set “high” again. This feature can be used as early warning function to notice the μ -controller about a battery voltage drop and a possible reset in a short time. Of course also any other voltage can be observed by this feature.

The user defines the threshold by the resistor-values R_{S1} and R_{S2} .

For the exact timing and calculation of the reset and sense timing and thresholds, please refer to the application section.

SKYTECH

تهیه و توزیع قطعات الکترونیک

Functional description

4.1 Electrical characteristics

Table 4 Electrical characteristics

$V_I = 13.5\text{ V}$, $-40^\circ\text{C} \leq T_j \leq 150^\circ\text{C}$; all voltages with respect to ground, positive current flowing into pin (unless otherwise specified)

Parameter	Symbol	Values			Unit	Note or Test Condition
		Min.	Typ.	Max.		
Output voltage	V_Q	3.23	3.30	3.37	V	$1\text{ mA} \leq I_Q \leq 100\text{ mA}$; $5.5\text{ V} \leq V_I \leq 16\text{ V}$
Output voltage	V_Q	3.20	3.30	3.40	V	$I_Q \leq 150\text{ mA}$; $5.5\text{ V} \leq V_I \leq 16\text{ V}$
Current limit	I_Q	250	400	500	mA	–
Current consumption; $I_q = I_I - I_Q$	I_q	–	65	105	μA	Inhibit ON; $I_Q \leq 1\text{ mA}$, $T_j < 85^\circ\text{C}$
Current consumption; $I_q = I_I - I_Q$	I_q	–	170	500	μA	Inhibit ON; $I_Q = 10\text{ mA}$
Current consumption; $I_q = I_I - I_Q$	I_q	–	0.7	2	mA	Inhibit ON; $I_Q = 50\text{ mA}$
Current consumption; $I_q = I_I - I_Q$	I_q	–	–	1	μA	$V_{\text{INH}} = 0\text{ V}$; $T_j = 25^\circ\text{C}$
Load regulation	ΔV_Q	–	5	30	mV	$I_Q = 1\text{ mA}$ to 100 mA
Line regulation	ΔV_Q	–	10	25	mV	$V_I = 6\text{ V}$ to 28 V ; $I_Q = 1\text{ mA}$
Power supply ripple rejection	$PSRR$	–	66	–	dB	$f_r = 100\text{ Hz}$; $V_r = 1\text{ V}_{\text{SS}}$; $I_Q = 100\text{ mA}$

Inhibit (TLE4299GMV33 only)

Inhibit OFF voltage range	$V_{\text{INH OFF}}$	–	–	0.8	V	V_Q off
Inhibit ON voltage range	$V_{\text{INH ON}}$	3.5	–	–	V	V_Q on
High input current	$I_{\text{INH ON}}$	–	3	5	μA	$V_{\text{INH}} = 5\text{ V}$
Low input current	$I_{\text{INH OFF}}$	–	0.5	2	μA	$V_{\text{INH}} = 0.8\text{ V}$

Reset generator

Switching threshold	V_{rt}	3.00	3.10	3.20	V	–
Reset threshold headroom	V_{RTHEAD}	50	200	300	mV	–
Reset pull up	R_{RO}	10	20	40	k Ω	–
Reset low voltage	V_R	–	0.17	0.40	V	$V_Q < 3.0\text{ V}$; internal R_{RO} ; $I_R = 1\text{ mA}$
External reset pull up	V_{Rext}	5.6	–	–	k Ω	Pull up resistor Q
Delay switching threshold	V_{DT}	1.6	1.85	2.35	V	–
Switching threshold	V_{ST}	0.35	0.50	0.60	V	–
Reset delay low voltage	V_D	–	–	0.1	V	$V_Q < V_{\text{RT}}$
Charge current	I_{ch}	2.0	3.5	6.0	μA	$V_D = 1\text{ V}$
Power-up reset delay time	t_d	36	51	60	ms	$C_D = 100\text{ nF}$
Reset reaction time	t_{rr}	0.5	1.2	3.0	μs	$C_D = 100\text{ nF}$

Functional description

Table 4 Electrical characteristics (cont'd)

$V_i = 13.5\text{ V}$, $-40^\circ\text{C} \leq T_j \leq 150^\circ\text{C}$; all voltages with respect to ground, positive current flowing into pin (unless otherwise specified)

Parameter	Symbol	Values			Unit	Note or Test Condition
		Min.	Typ.	Max.		
Reset adjust switching threshold	VRADJ TH	1.26	1.36	1.44	V	$V_Q < 3.5\text{ V}$
Input voltage sense						
Sense threshold high	$V_{SI\ high}$	1.34	1.45	1.54	V	–
Sense threshold low	$V_{SI\ low}$	1.26	1.36	1.44	V	–
Sense input switching hysteresis	$V_{SI\ HYST}$	50	90	130	mV	$V_{SI\ HYST} = V_{SI\ high} - V_{SI\ low}$
Sense output low voltage	$V_{SO\ low}$	–	0.1	0.4	V	$V_{SI} < 1.20\text{ V}$; $V_i > 4.2\text{ V}$; $I_{SO} = 1\text{ mA}$
External SO pull up resistor	$R_{SO\ ext}$	5.6	–	–	k Ω	–
Sense input current	I_{SI}	-1	0.1	1	μA	$S_i > 1.0\text{ V}$
Sense high reaction time	$t_{pd\ SO\ LH}$	–	2.4	4.0	μs	$R_{SO\ ext} = 5.6\text{ k}\Omega$
Sense low reaction time	$t_{pd\ SO\ HL}$	–	2.5	6.0	μs	$R_{SO\ ext} = 5.6\text{ k}\Omega$

Note: The listed characteristics are ensured over the operating range of the integrated circuit. Typical characteristics specify mean values expected over the production spread. If not otherwise specified, typical characteristics apply at $T_A = 25^\circ\text{C}$ and the given supply voltage.

SKYTECH

تهیه و توزیع قطعات الکترونیک

Functional description

4.2 Test circuit

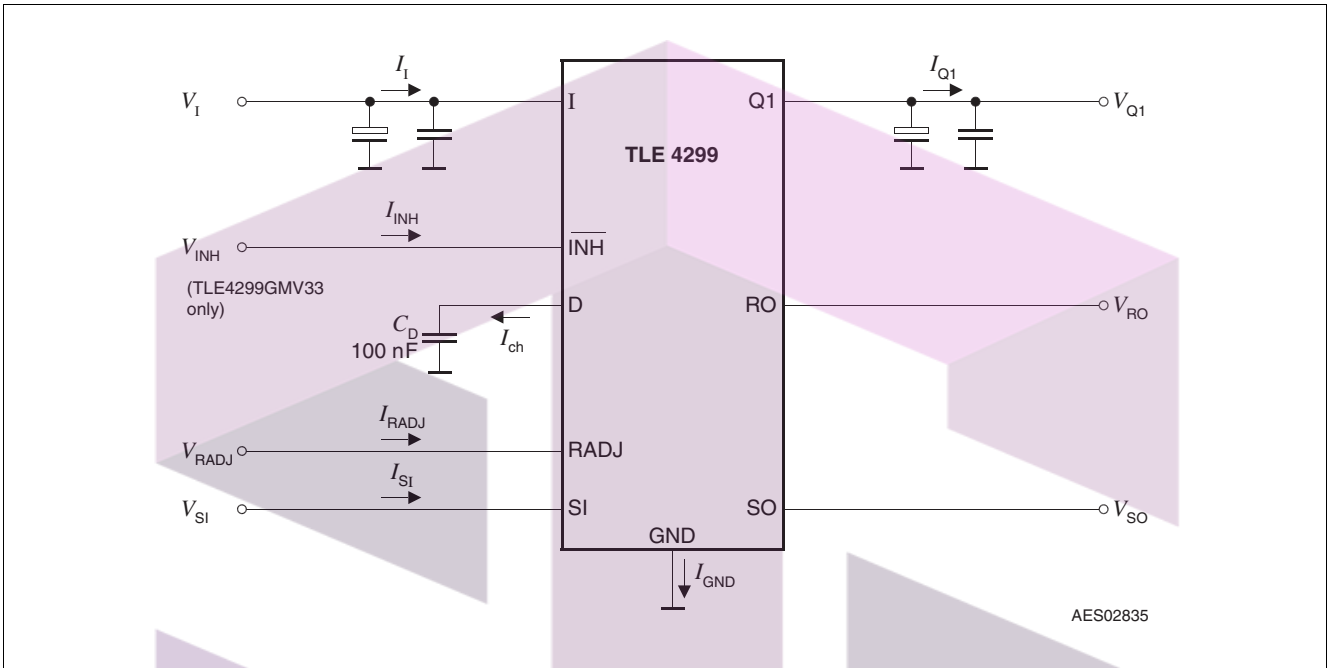

Figure 5 Measurement circuit

SKYY↑TECH

تهیه و توزیع قطعات الکترونیک

Functional description

4.3 Typical performance characteristics

Current consumption I_q versus junction temperature T_j

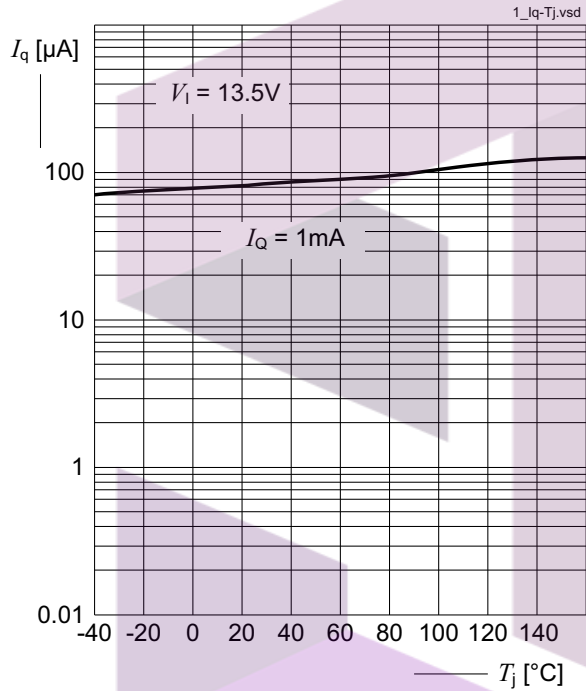

Current consumption I_q versus output current I_Q

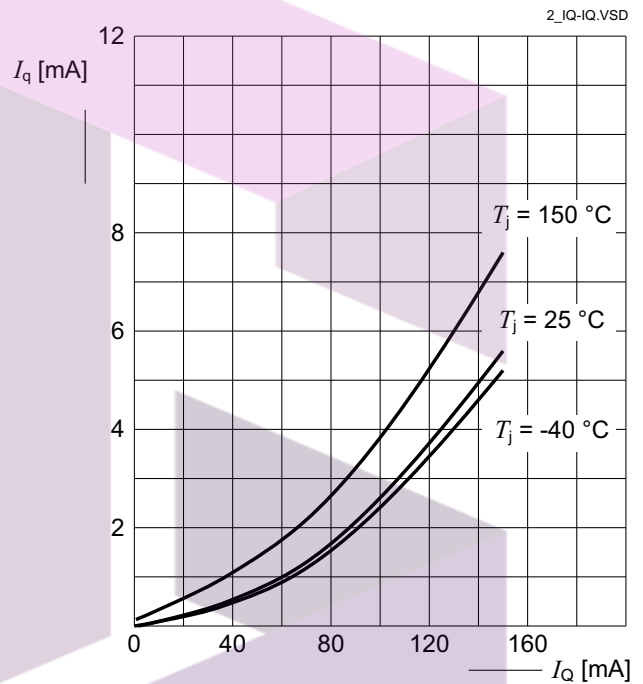

Current consumption I_q versus input voltage V_i

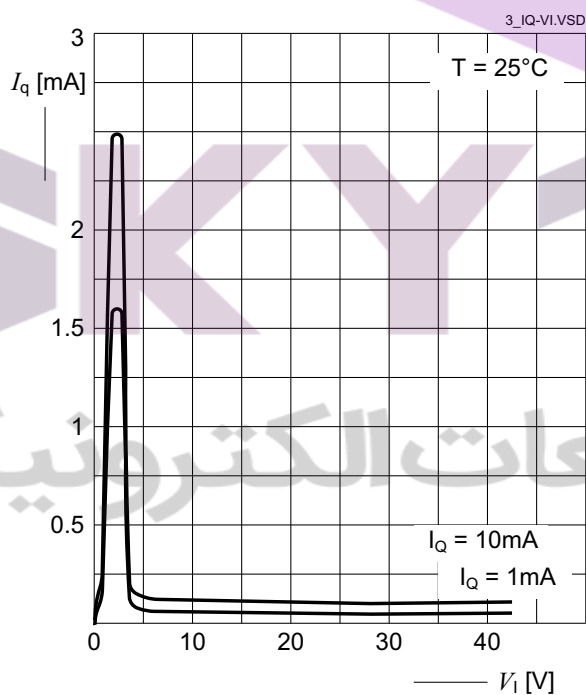

Output voltage V_Q versus junction temperature T_j

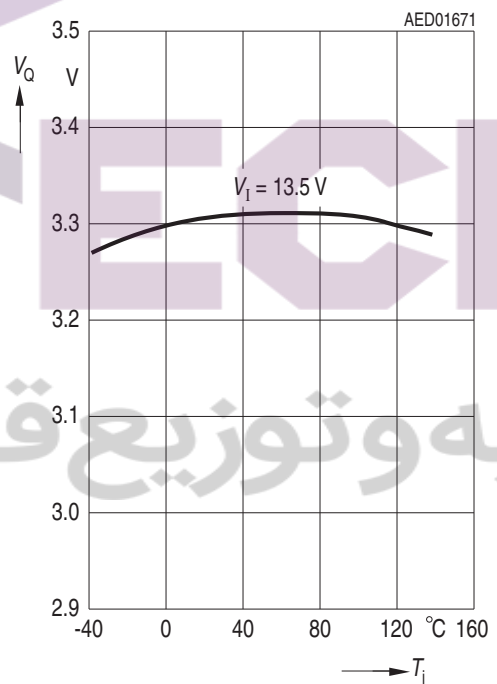

Functional description

Maximum output current I_Q versus junction temperature T_j

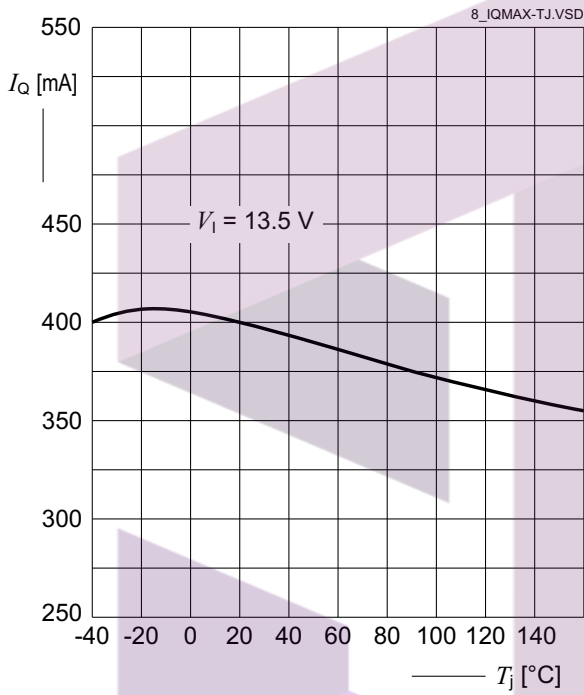

Reverse output current I_Q versus output voltage V_Q

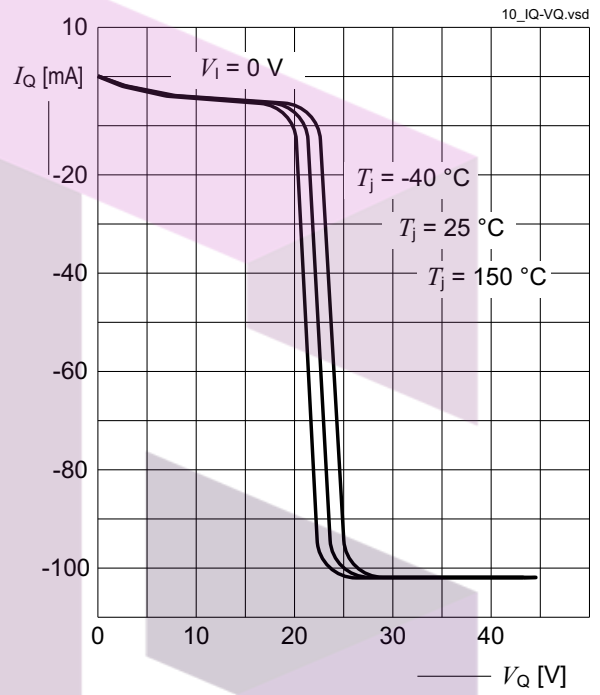

Maximum output current I_Q versus input voltage V_1

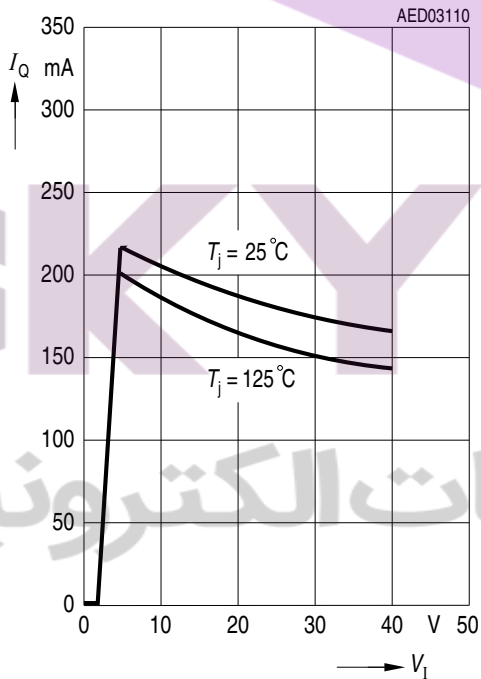

Output voltage V_Q at input voltage extremes

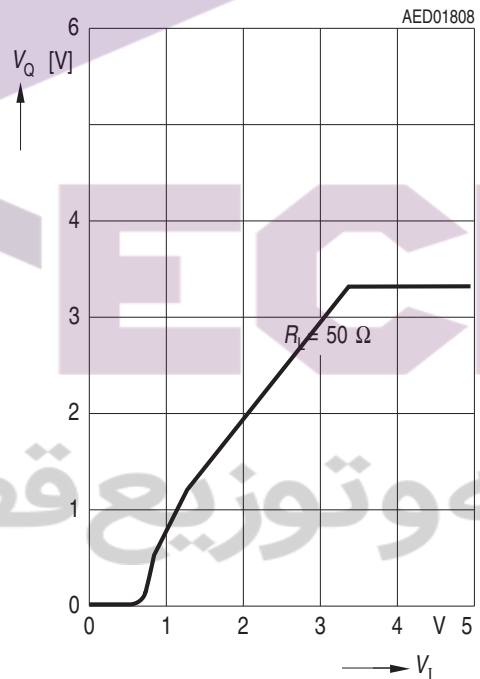

Functional description

Region of stability

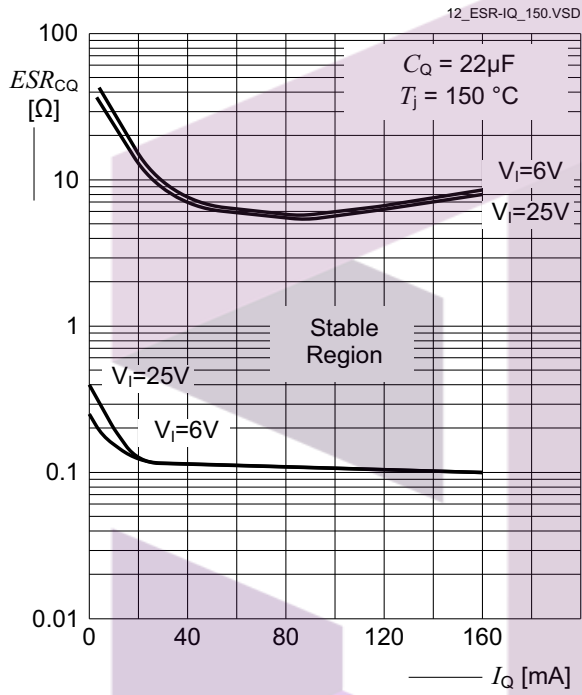

Power supply ripple rejection PSRR versus Frequency f

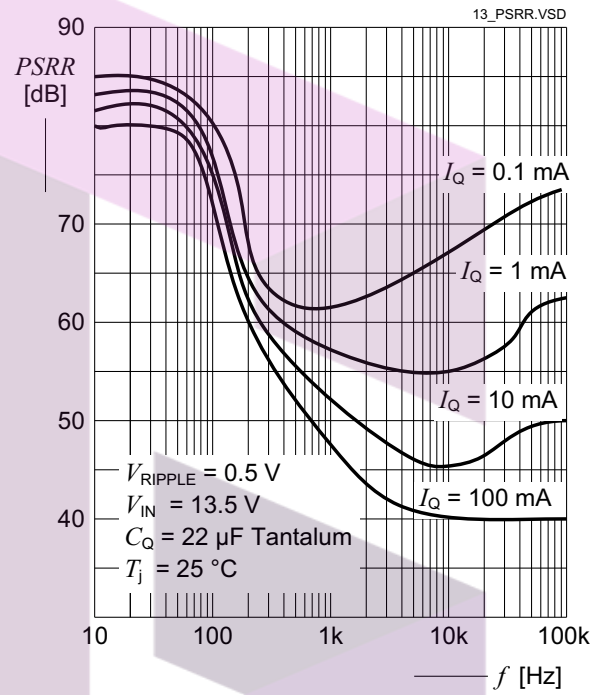

Region of stability

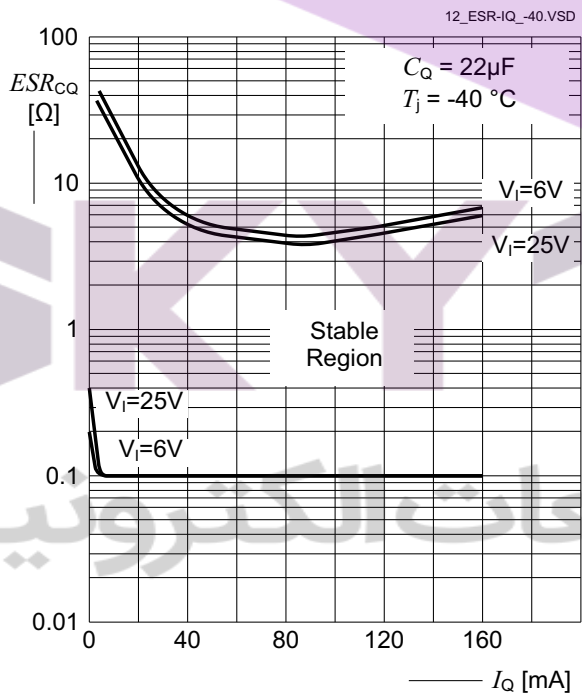

Load transient response peak voltage D_{VQ}

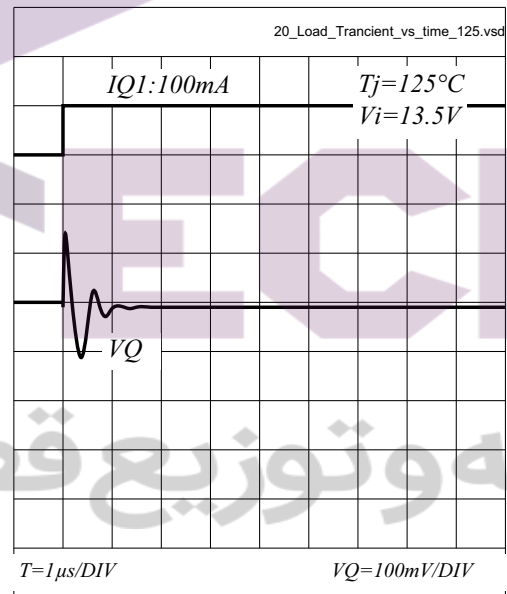

Functional description

Line transient response peak voltage D_{VQ}

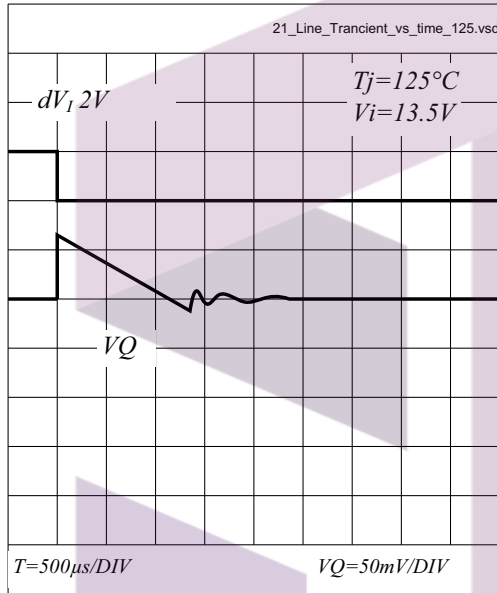

Inhibit input current at input voltage extremes (INH = OFF)

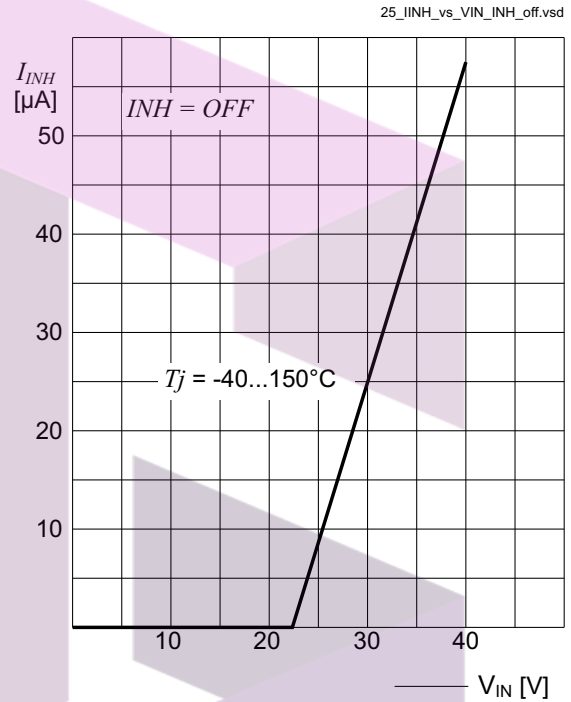

Inhibit input current I_{INH} at inhibit input voltage extremes

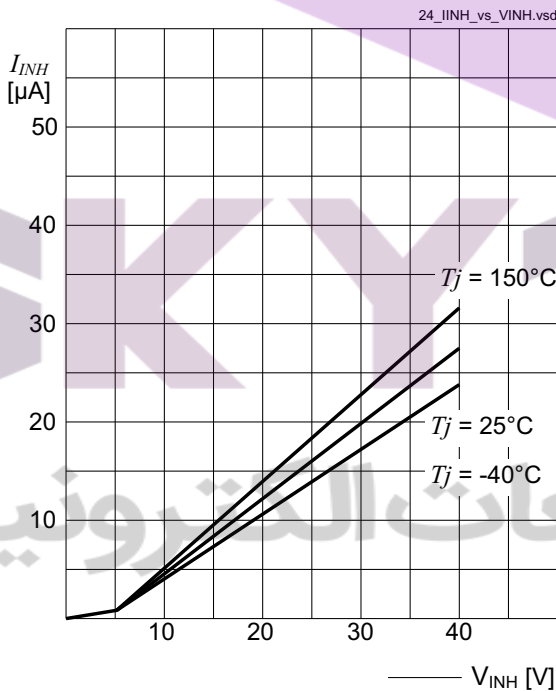

Reset trigger threshold V_{RT} versus junction temperature T_j

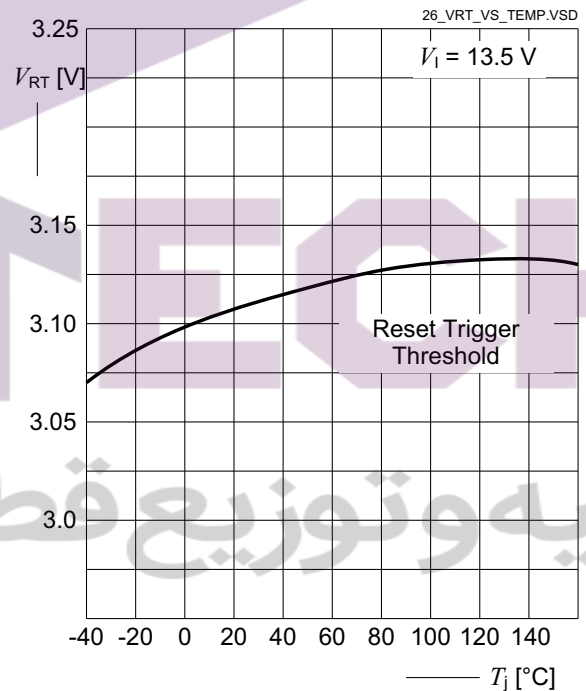

Functional description

Reset delay time T_{RD} versus junction temperature T_j

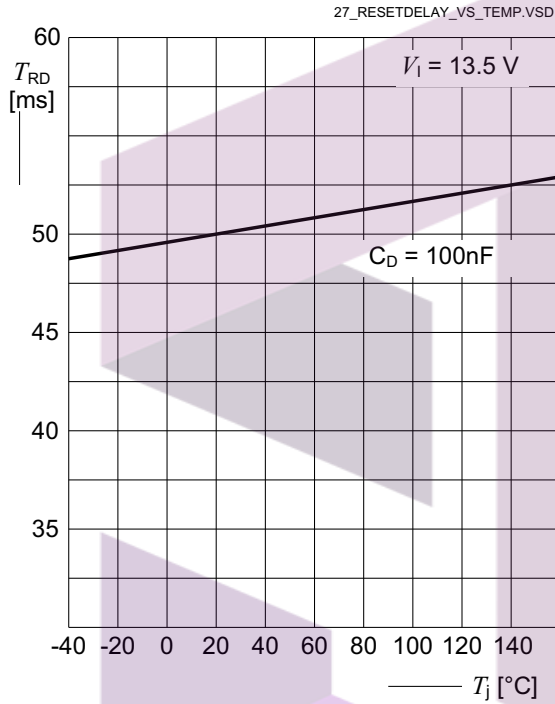

Sense threshold high versus junction temperature T_j

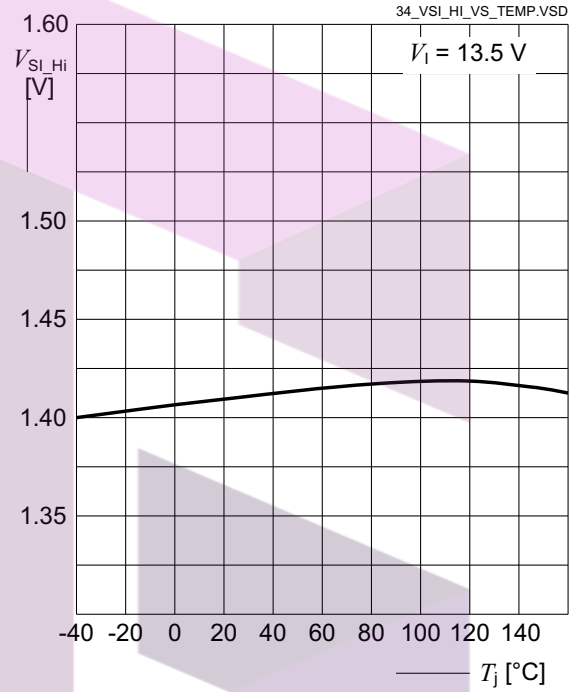

Delay capacitor charge current versus junction temperature T_j

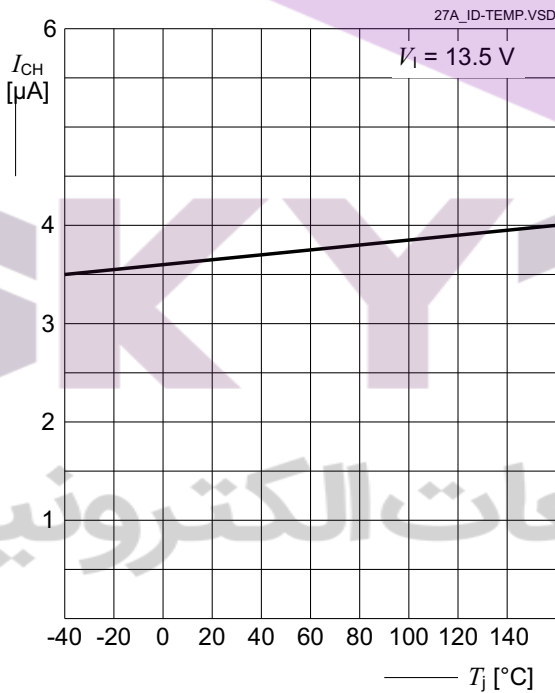

Sense threshold low versus junction temperature T_j

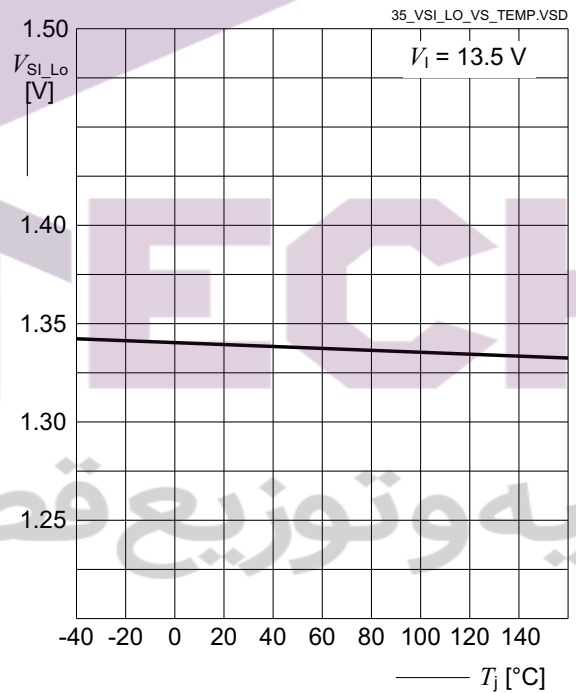

5 Application information

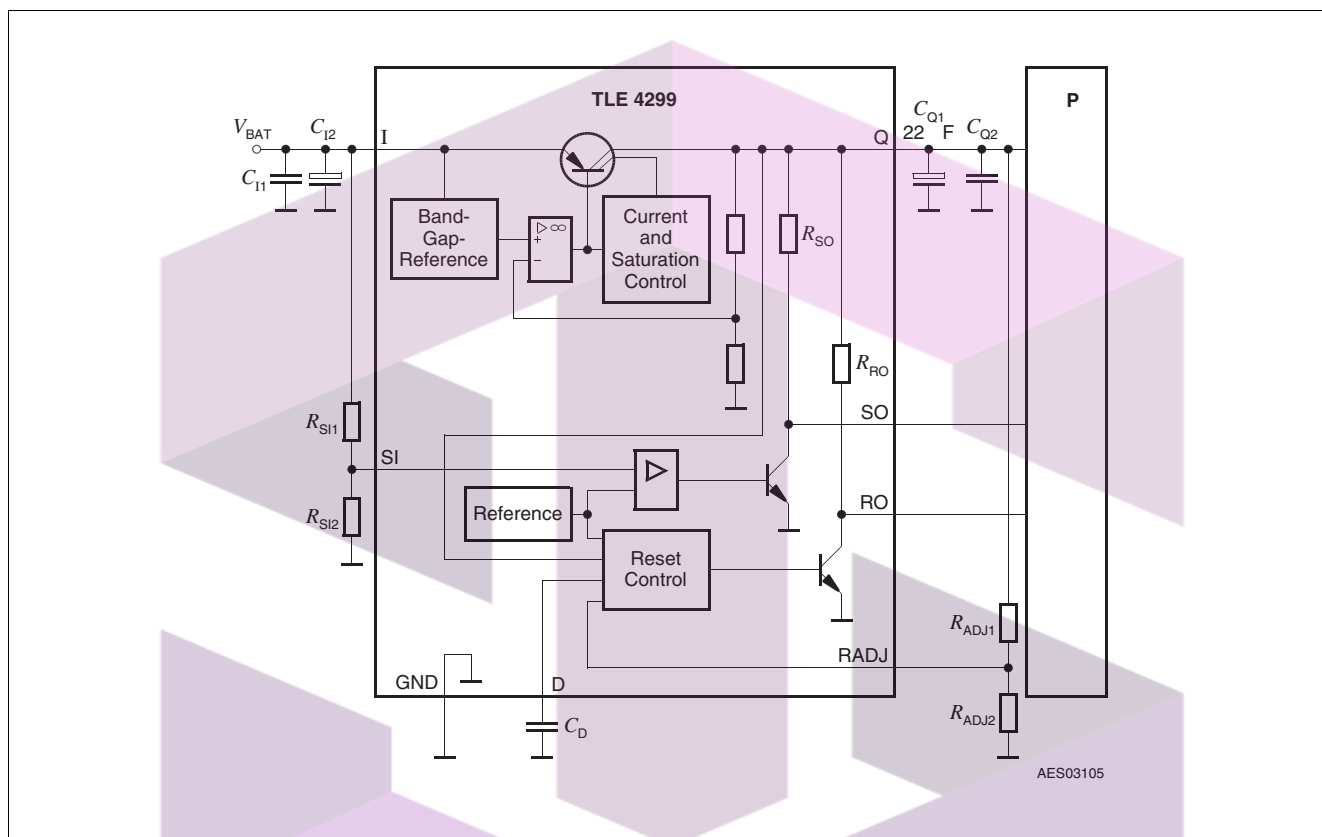

Figure 6 Application diagram TLE4299GV33

SKYYTECH

تهیه و توزیع قطعات الکترونیک

Application information

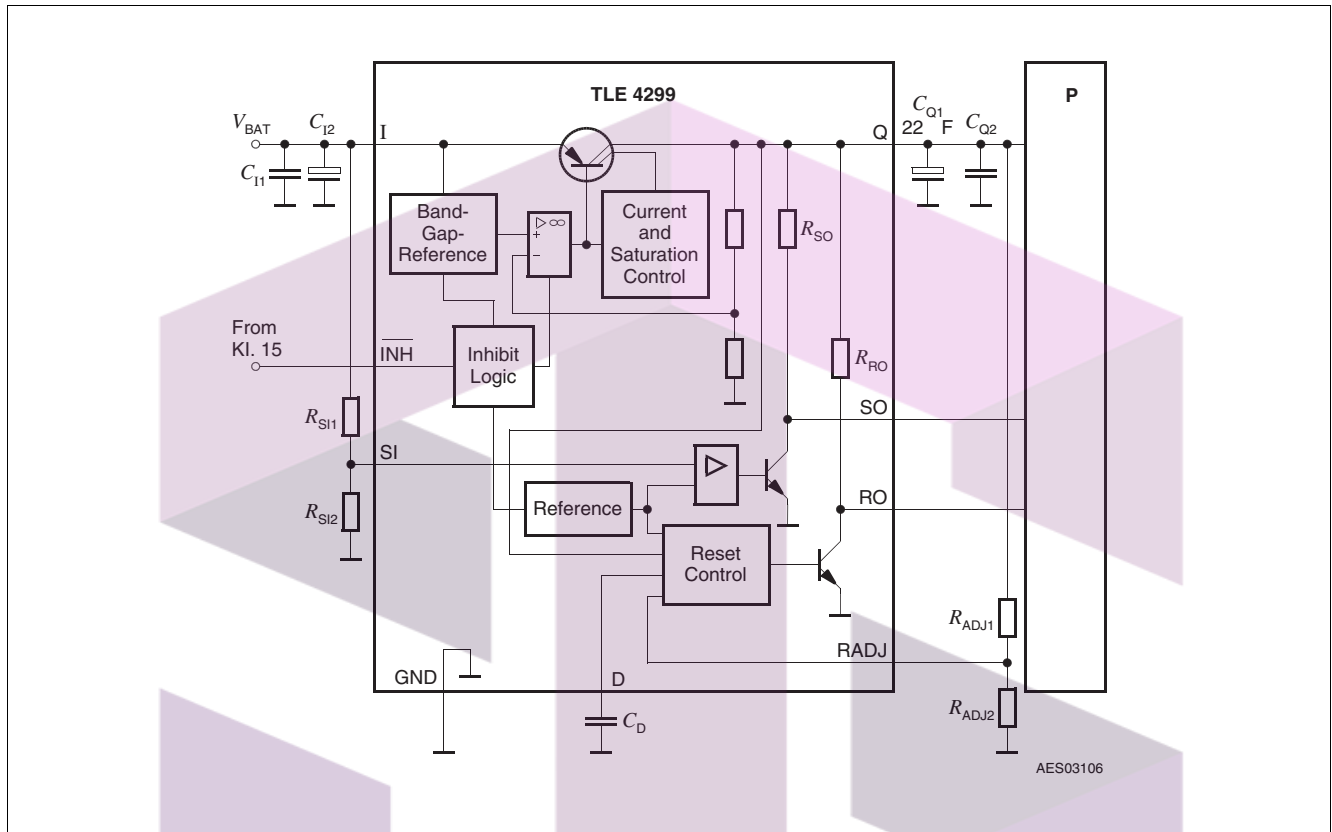

Figure 7 Application diagram with inhibit function TLE4299GMV33

The TLE4299V33 supplies a regulated 3.3 V output voltage with an accuracy of 2% for an input voltage between 4.4 V and 45 V in the temperature range of $T_j = -40$ to 150°C , in an output current range of 1 mA to 100 mA.

The device is capable to supply 150 mA with an accuracy of 3%. For protection at high input voltage above 25 V, the output current is reduced (SOA protection).

An input capacitor is necessary for compensating line influences and to limit steep input edges. A resistor of approx. $1\ \Omega$ in series with C_i , can damp the LC of the input inductivity and the input capacitor.

The voltage regulator requires for stability an output capacitor C_o of at least $22\ \mu\text{F}$ with an $0.4\ \Omega < \text{ESR} < 3.7\ \Omega$ for the whole load- and temperature range. For more detailed information, refer to the characteristic curves.



Application information

5.1 Reset

The power on reset feature is necessary for a defined start of the microprocessor when switching on the application. For the reset delay time after the output voltage of the regulator is above the reset threshold, the reset signal is set “high” again. The reset delay time is defined by the reset delay capacitor C_D at pin D.

The undervoltage reset circuitry supervises the output voltage. In case V_Q decreases below the reset threshold the reset output is set “low” after the reset reaction time. The reset “low” signal is generated down to an output voltage V_Q to 1 V. Both the reset reaction time and the reset delay time is defined by the capacitor value.

The power on reset delay time is defined by the charging time of an external delay capacitor C_D .

(5.1)

$$C_D = (t_d \times I_D) / (\Delta V)$$

(5.2)

$$t_d = C_D \times \Delta V / I_D$$

With	C_D	Reset delay capacitor
	t_d	Reset delay time
	$\Delta V = VDT$	Typical 1.8 V for power up reset
	I_{ch}	Charge current typical 3.5 μA

For a delay capacitor $C_D = 100$ nF the typical power on reset delay time is 51 ms.

The reset reaction time t_{RR} is the time it takes the voltage regulator to set reset output “low” after the output voltage has dropped below the reset threshold. It is typically 1.2 μs for delay capacitor of 100 nF. For other values for C_D the reaction time can be estimated using the following equation:

(5.3)

$$t_{RR} \sim (10ns) / (nF \times C_D)$$

SKYTECH

تهیه و توزیع قطعات الکترونیک

Application information

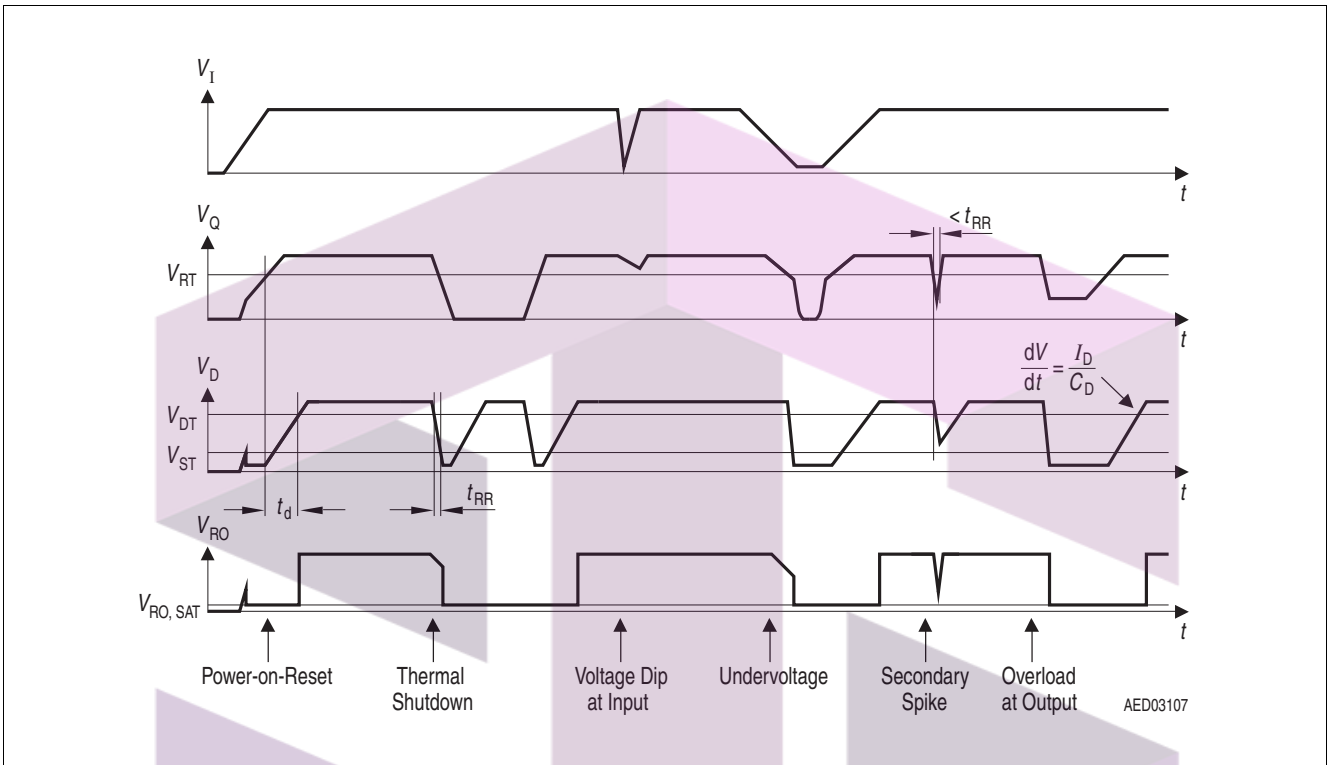

Figure 8 Reset timing diagram

The reset output is an open collector output. An external pull-up can be added with a resistor value of at least 5.6 kΩ.

In addition the reset switching threshold can be adjusted by an external voltage divider.

The feature is useful for microprocessors which ensure safe operation down to voltages below the internally set reset threshold of 3.10 V typical. If the internal used reset threshold of typical 3.10 V is used, the pin R_{ADJ} must be connected to GND.

If a lower reset threshold is required by the system, a voltage divider defines the reset threshold V_{Rth} between 2.5 V and 3.10 V as long as the Input Voltage $V_I > 4.4$ V

(5.4)

$$V_{Rth} = V_{RADJTH} \times (R_{ADJ1} + R_{ADJ2}) / R_{ADJ2}$$

V_{RADJTH} is typical 1.36 V.



Application information

5.2 Early warning

The early warning function compares a voltage defined by the user to an internal reference voltage. Therefore the supervised voltage must be scaled down by an external voltage divider in order to compare it to the internal sense threshold of typical 1.36 V. The sense output pin is set “low”, when the voltage at SI falls below this threshold.

A typical example where the circuit can be used is to supervise the input voltage V_I to give the microcontroller a prewarning of low battery condition.

Calculation to the voltage divider can be easily done since the sense input current can be neglected.

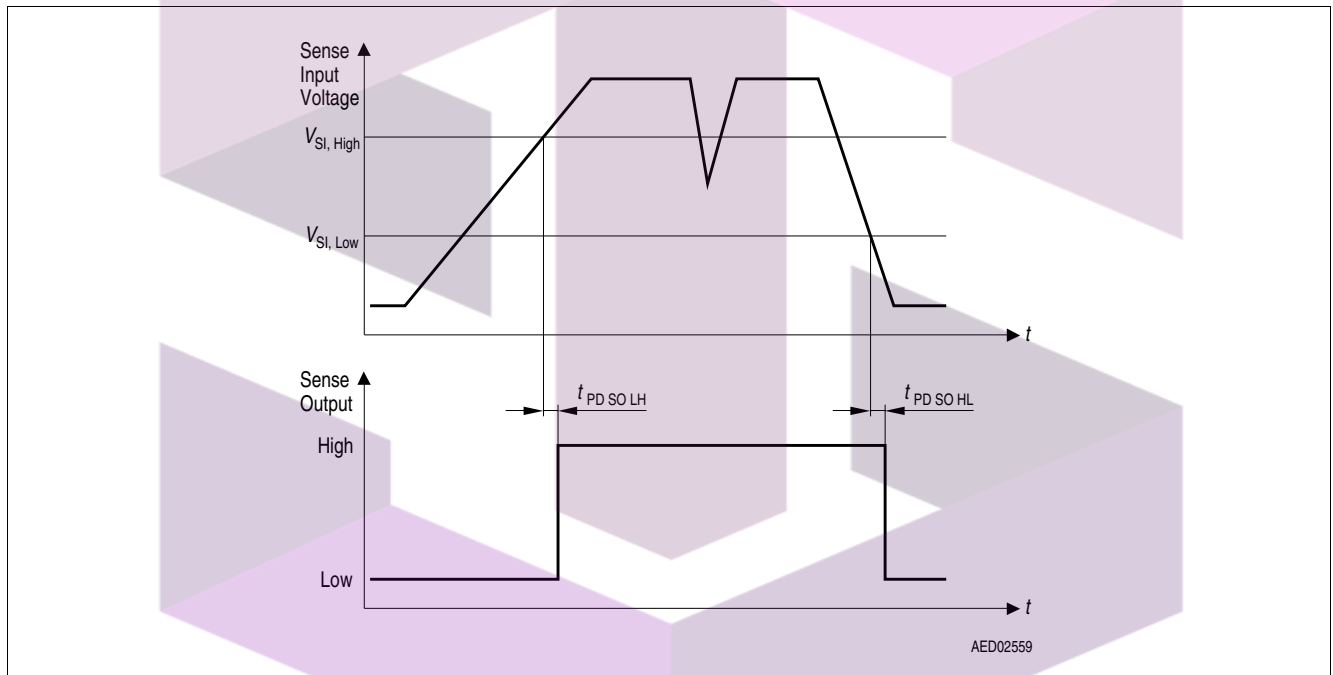

Figure 9 Sense timing diagram

(5.5)

$$V_{thHL} = (R_{SI1} + R_{SI2}) / R_{SI2} \times V_{SIlow}$$

(5.6)

$$V_{thLH} = (R_{SI1} + R_{SI2}) / R_{SI2} \times V_{SIhigh}$$

The sense in comparator uses a hysteresis of typical 90 mV. This hysteresis of the supervised threshold is multiplied by the resistor dividers amplification $(R_{SI1} + R_{SI2}) / R_{SI1}$.

The sense in comparator can also be used for receiving data with a threshold of typical 1.36 V and a hysteresis of 90 mV. Of course also the data signal can be scaled down with a resistive divider as shown above. With a typical delay time of 2.5 μ s for positive transitions and 2.4 μ s for negative transitions receiving data of up to 100 kBaud are possible. The sense output is an open collector output.

Package information

6 Package information

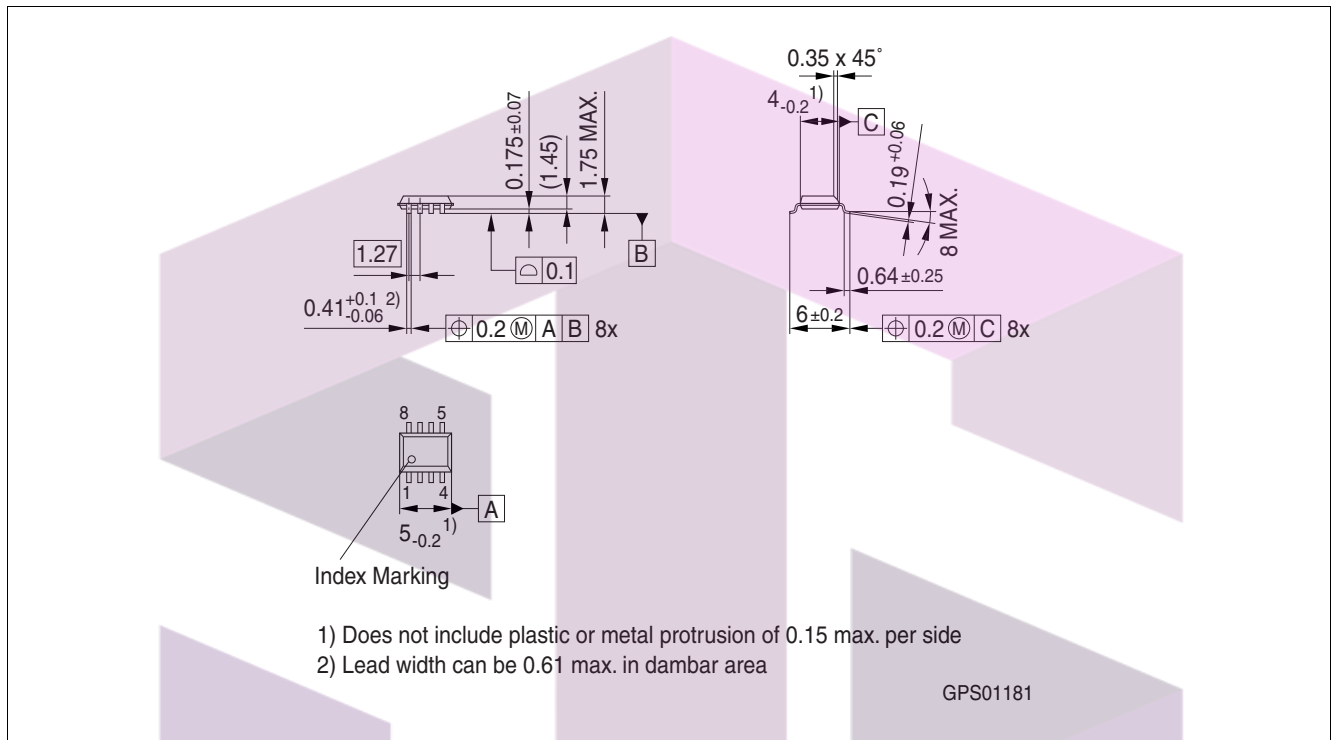

Figure 10 PG-DSO-8¹⁾

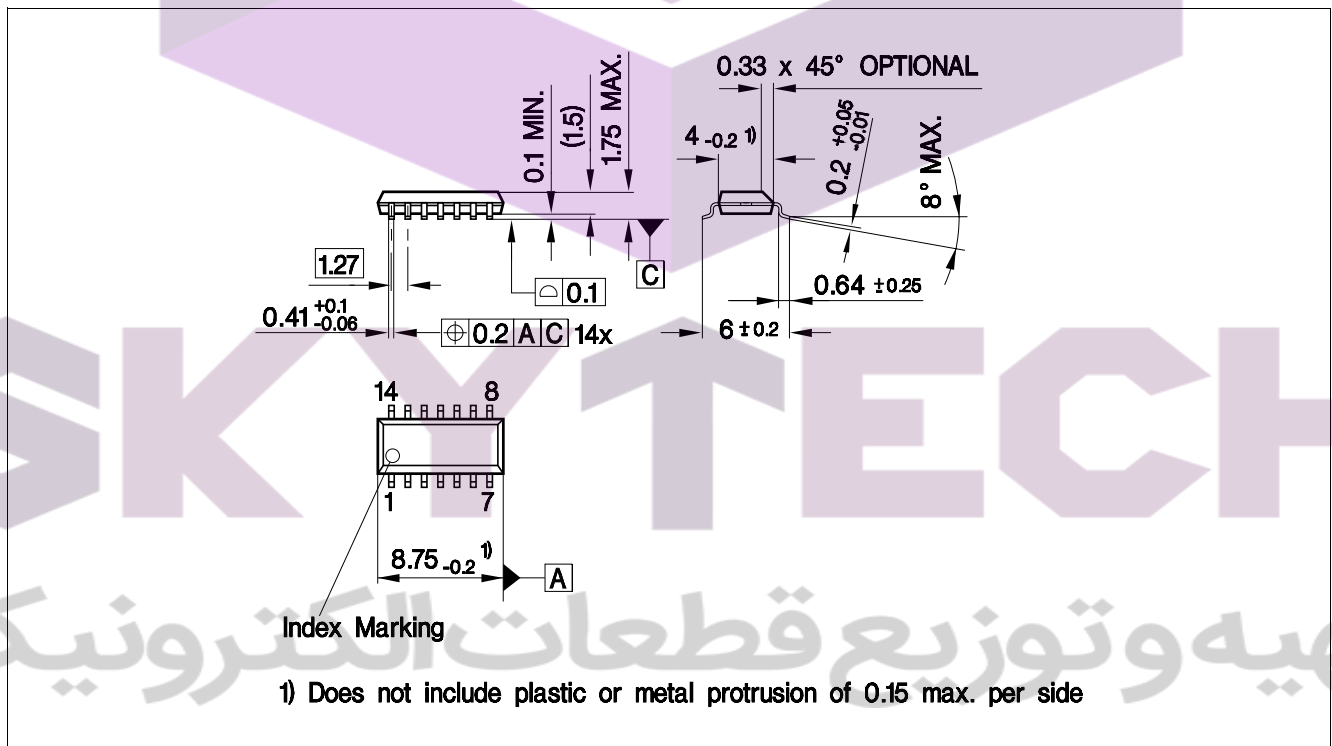

Figure 11 PG-DSO-14¹⁾

1) Dimensions in mm

Package information

Green Product (RoHS compliant)

To meet the world-wide customer requirements for environmentally friendly products and to be compliant with government regulations the device is available as a green product. Green products are RoHS-Compliant (i.e Pb-free finish on leads and suitable for Pb-free soldering according to IPC/JEDEC J-STD-020).

Further information on packages

<https://www.infineon.com/packages>



SKYYTECH

تهیه و توزیع قطعات الکترونیک

Revision history

7 Revision history

Revision	Date	Changes
1.2	2018-11-22	Update layout and structure Updated packaged drawing “PG-DSO-14” Editorial changes
1.1	2007-10-17	Initial version of RoHS-compliant derivate of TLE4299 Page 1 : AEC certified statement added Page 1 and Page 22 ff: RoHS compliance statement and Green product feature added Page 1 and Page 22 ff: Package drawing changed to RoHS compliant version Legal Disclaimer updated

SKYTECH

تهیه و توزیع قطعات الکترونیک



Trademarks

All referenced product or service names and trademarks are the property of their respective owners.

Edition 2018-11-26

**Published by
Infineon Technologies AG
81726 Munich, Germany**

**© 2018 Infineon Technologies AG.
All Rights Reserved.**

**Do you have a question about any
aspect of this document?**

Email: erratum@infineon.com

**Document reference
Z8F55167460**

IMPORTANT NOTICE

The information given in this document shall in no event be regarded as a guarantee of conditions or characteristics ("Beschaffheitsgarantie").

With respect to any examples, hints or any typical values stated herein and/or any information regarding the application of the product, Infineon Technologies hereby disclaims any and all warranties and liabilities of any kind, including without limitation warranties of non-infringement of intellectual property rights of any third party.

In addition, any information given in this document is subject to customer's compliance with its obligations stated in this document and any applicable legal requirements, norms and standards concerning customer's products and any use of the product of Infineon Technologies in customer's applications.

The data contained in this document is exclusively intended for technically trained staff. It is the responsibility of customer's technical departments to evaluate the suitability of the product for the intended application and the completeness of the product information given in this document with respect to such application.

For further information on technology, delivery terms and conditions and prices, please contact the nearest Infineon Technologies Office (www.infineon.com).

WARNINGS

Due to technical requirements products may contain dangerous substances. For information on the types in question please contact your nearest Infineon Technologies office.

Except as otherwise explicitly approved by Infineon Technologies in a written document signed by authorized representatives of Infineon Technologies, Infineon Technologies' products may not be used in any applications where a failure of the product or any consequences of the use thereof can reasonably be expected to result in personal injury.